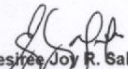

TABLE 1: SPECIFICATIONS OF OFFICE FURNITURES

LOT NO.	GENERAL DESCRIPTION	SPECIFICATIONS	QTY	Unit	UNIT COST	TOTAL COST (PHP)
1	Office Partitions with Built in Table and Mobile Pedestal	a.) Panel Thickness: 3.2cm / 32mm, Aluminum powder coated, panel-base system, Frame color-flash silver/anodized, Fabric Tiles, Top: Glass Tiles, Middle: Light Gray, Bottom: Sky Blue, b.) Work Surface/Table, 1 pc - 120x60cm, c.) Cubicle partition: 1 pc - H120xW120x3.2cm, 2 pcs - H120xW60x3.2cm,	19	Sets	22,500.00	427,500.00
	Heavy Duty Full-back Chair	-Midback Chair with polyurethane leather seatrest and backrest with thick padded armrest, with gaslift mechanism for seat height adjustment, lockable tilting function, nylon star base with casters -Metal armrest, gaslift mechanism chrome star base with caster -Black color	27	Units	9,000.00	243,000.00
	Conference Table	8 Seater, Dimension : W1800 x D1200 x H750 mm, Material ; MFC Board	1	Units	15,000.00	15,000.00
	Heavy Duty High Back Chair with Head Rest	-High back, leather seatrest and backrest with padded metal armrest, gaslift mechanism chrome star base with caster	1	Units	23,500.00	23,500.00
	Executive Table	Main Table: Minimum of 1500mm(L) x 700mm (W) x 750mm Ht Side Cabinet: 1000mm L x 400mm D x 620mm Ht Top and Legs : 25 mm thick Cabinet Carcass: Minimum of 16 mm thick	1	Units	28,000.00	28,000.00
	<b>SUB-TOTAL</b>					<b>737,000.00</b>
2	4 Drawer Lateral Cabinet	-lateral cabinet features all metal construction -steel ball bearing -gauge: 0.9mm or gauge 20 -central locking system -color: silver -dimension: W90 x D45 x H136 cm	6	Units	19,600.00	117,600.00
<b>SUB-TOTAL</b>					<b>117,600.00</b>	
3	Window Blinds	- Material: Polyester - Combination-type blinds - Shall be duo shade; Shall have two layers of translucent and opaque horizontal striped color - Can be rolled up manually - Color: Sky blue or dark blue	820	Sq.Ft	400.00	328,000.00
<b>SUB-TOTAL</b>					<b>328,000.00</b>	
4	Bulletin Board with Glass Cover	-Minimum Dimension : 6ft (L) x 4ft (W) x 2" (Depth) -Enclosed Bulletin Board with Sliding Tempered Glass Doors, -Frame: Black Aluminum, -Wall Mounted -Notice Board with Z-Bar Wall Bracket, -With Locking Doors - Shall include labor and materials in free installation	1	sets	14,900.00	14,900.00
<b>SUB-TOTAL</b>					<b>14,900.00</b>	
5	Kitchen Cabinet	Material: Synthetic Granite top marin plywood Color: White, Brown Dimension: W200 cm x D40 cm x H82 cm	1	lot	30,000.00	30,000.00
<b>SUB-TOTAL</b>					<b>30,000.00</b>	
<b>GRAND TOTAL</b>					<b>1,227,500.00</b>	

Prepared by:

  
Engr. Desires Joy R. Salvatera  
Procurement Coordinator, BAFE -EPDSD

Approved by:

  
Engr. Allan C. Galeng  
Engineer IV, BAFE - EPDSD

## TERMS OF REFERENCE

### SUPPLY, DELIVERY AND INSTALLATION OF BULLETIN BOARD WITH GLASS COVER

#### BACKGROUND:

The Bureau of Agricultural and Fisheries Engineering (BAFE) Office is currently located at the 4<sup>th</sup> floor of the DA building. With its full operationalization, and filling up of positions, the present area being occupied by BAFE will no longer be adequate thus, the need for a bigger office space and additional office equipment. The Bulletin Board with Glass Cover to be procured will be used for the posting of important announcements, and information for BAFE staff, clients, and relevant stakeholders.

#### APPROVED BUDGET FOR THE CONTRACT (ABC):

The Approved Budget for the Contract is Fourteen Thousand Nine Hundred Pesos (Php 14,900.00) inclusive of all taxes.

#### TECHNICAL SPECIFICATIONS:

ITEM/PARTICULARS	Quantity	TECHNICAL SPECIFICATIONS
Bulletin Board with frame and glass cover	1 set	<ul style="list-style-type: none"><li>• Minimum Dimension : 6ft (L) x 4ft (W) x 2" (Depth)</li><li>• Enclosed Bulletin Board with Sliding Tempered Glass Doors</li><li>• Frame: Aluminum with silver finish</li><li>• Wall Mounted</li><li>• Notice Board with Z-Bar Wall Bracket</li><li>• With Locking Doors</li><li>• Shall include labor and materials in free installation</li></ul> <i>(See picture in Annex A)</i>

#### SCHEDULE OF DELIVERY:

The schedule of delivery should be Thirty (30) days upon receipt of Notice of Proceed.

#### SCHEDULE OF INSTALLATION:

Installation shall not exceed ten (10) working days.

#### WARRANTY

One (1) year warranty on all parts.

**PAYMENT**

Payment shall be done within thirty (30) calendar days upon receipt, inspection and installation of the Bulletin Board with glass cover including documents such as Official Receipt and other necessary documents.

**PREPARED BY:**

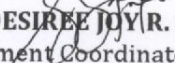
  
**ENGR. DESIREE JOY R. SALVATERA**  
Procurement Coordinator, BAFE - EPDSD

**APPROVED BY:**

  
**ENGR. ALLAN C. COLENG**  
Engineer IV, BAFE - EPDSD

**ANNEX A: SAMPLE PICTURE**

CMB & ME 2012

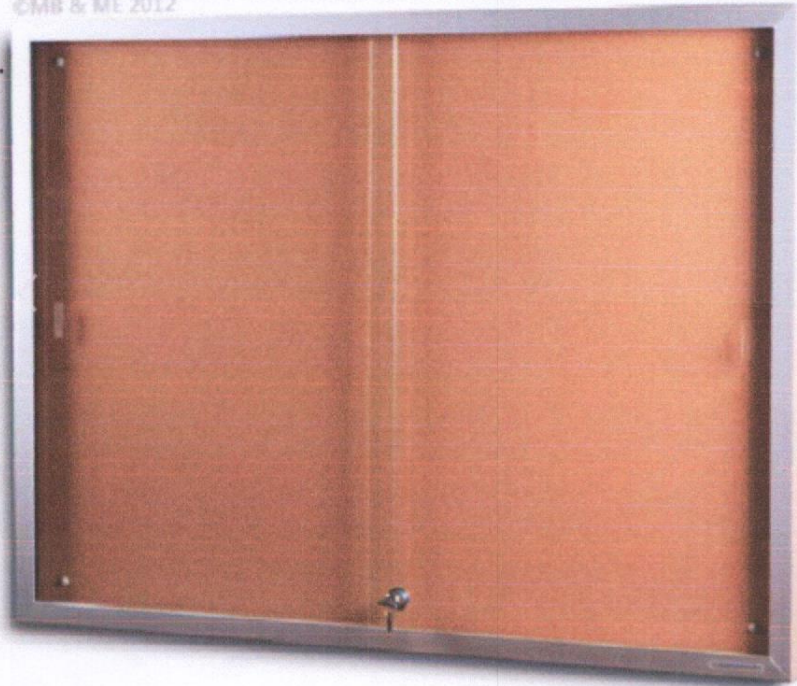

## TERMS OF REFERENCE

### SUPPLY, DELIVERY AND INSTALLATION OF CUBICLE WITH BUILT-IN TABLE AND MOBILE PEDESTAL

#### BACKGROUND:

The Bureau of Agricultural and Fisheries Engineering (BAFE) Office is currently located at the 4<sup>th</sup> floor of the DA building. With its full operationalization, and filling up of positions, the present area being occupied by BAFE will no longer be adequate thus, the need for a bigger office space and additional office equipment. The Cubicle with built-in table and mobile pedestal to be procured will be used by the additional staff upon the transfer of BAFE office to the Sugar Regulatory Administration (SRA) Building.

#### APPROVED BUDGET FOR THE CONTRACT (ABC):

The Approved Budget for the Contract is Four Hundred Twenty Seven Thousand Five Hundred Pesos (Php 427,500.00) inclusive of all taxes.

#### TECHNICAL SPECIFICATIONS:

ITEM/PARTICULARS	Quantity	TECHNICAL SPECIFICATIONS
Cubicle with built-in table and mobile pedestal	19 sets	a.) Panel Thickness: 3.2cm / 32mm, Aluminum powder coated, panel-base system, Frame color-flash silver/anodized, Fabric Tiles, Top: Glass Tiles, Middle: Light Gray, Bottom: Sky Blue, b.) Work Surface/Table, 1 pc - 120x60cm, c.) Cubicle partition: 1 pc - H120xW120x3.2cm, 2 pcs - H120xW60x3.2cm, d.) Pedestal Cabinet: 1 pc. 51.5cmx41.5cmx63.5cm (approx.) • Shall include labor and materials in free installation (See picture in Annex A)

#### SCHEDULE OF DELIVERY:

The schedule of delivery should be Thirty (30) days upon receipt of Notice of Proceed.

**ANNEX A: SAMPLE PICTURE**

**A.) OFFICE CUBICLE**

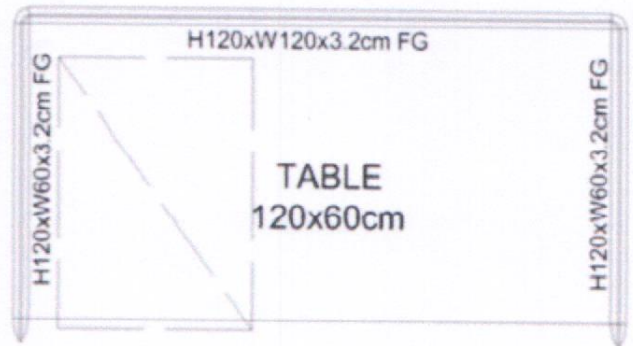

**TOP VIEW**



**Bullet SERIES**

Panel Thickness = 3.2cm / 32mm

\*Aluminum powder coated, Panel-base system

\*frame color - flash silver/anodized

**SCHEDULE OF INSTALLATION:**

Installation shall not exceed ten (10) working days.

**WARRANTY**

One (1) year warranty on all parts.

**PAYMENT**

Payment shall be done within thirty (30) calendar days upon receipt, inspection and installation of the cubicle with built-in table and mobile pedestal, including documents such as Official Receipt and other necessary documents.

**PREPARED BY:**

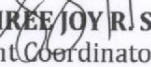
  
**ENGR. DESIREE JOY R. SALVATERA**  
Procurement Coordinator, BAFE - EPDSD

**APPROVED BY:**

  
**ENGR. ALLAN C. COLENG**  
Engineer IV, BAFE - EPDSD